

Positionsschema – Elektroapparate

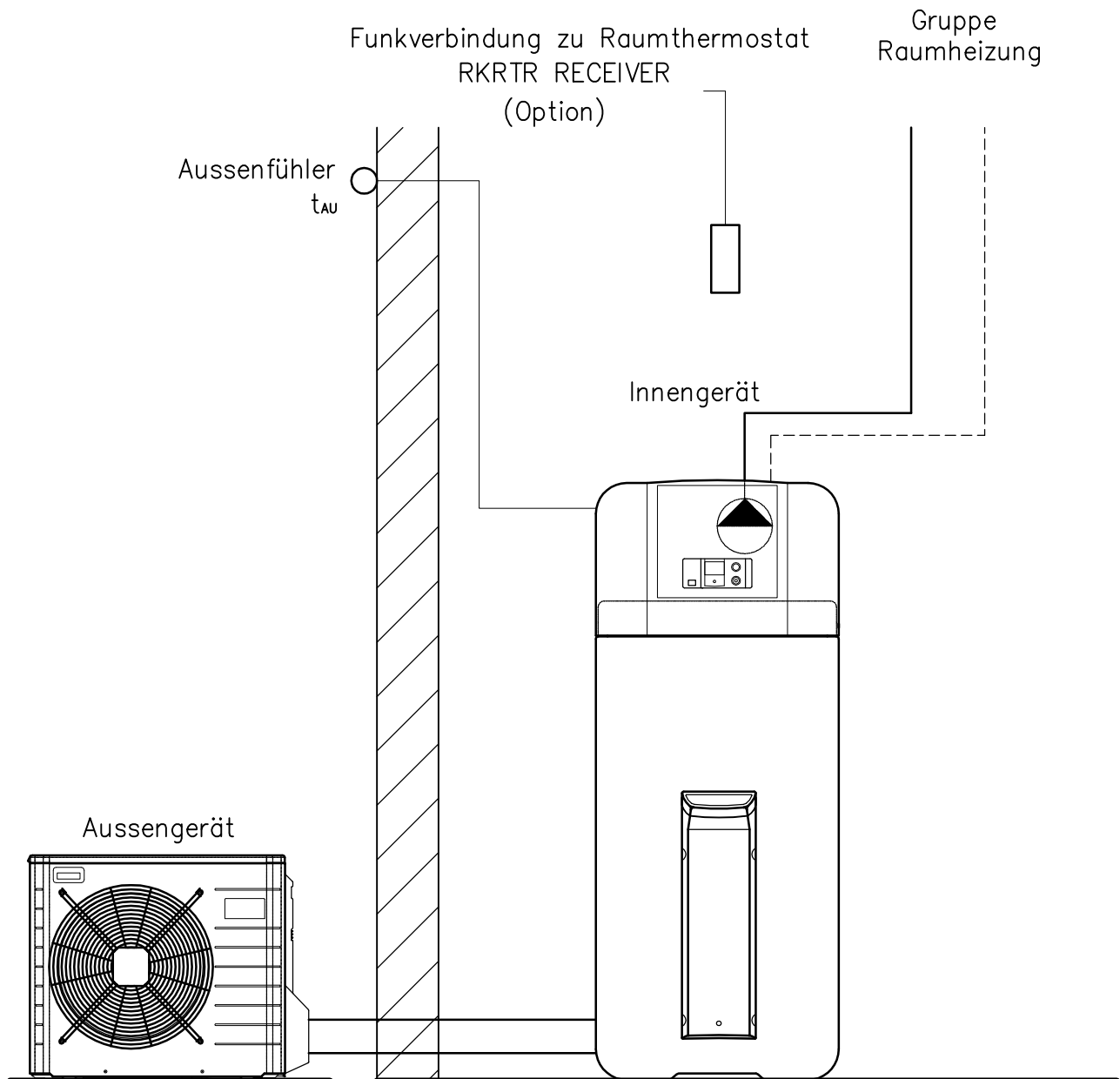

Hydraulik für Heizungsmontage ungültig

Einspeisung Aussengerät

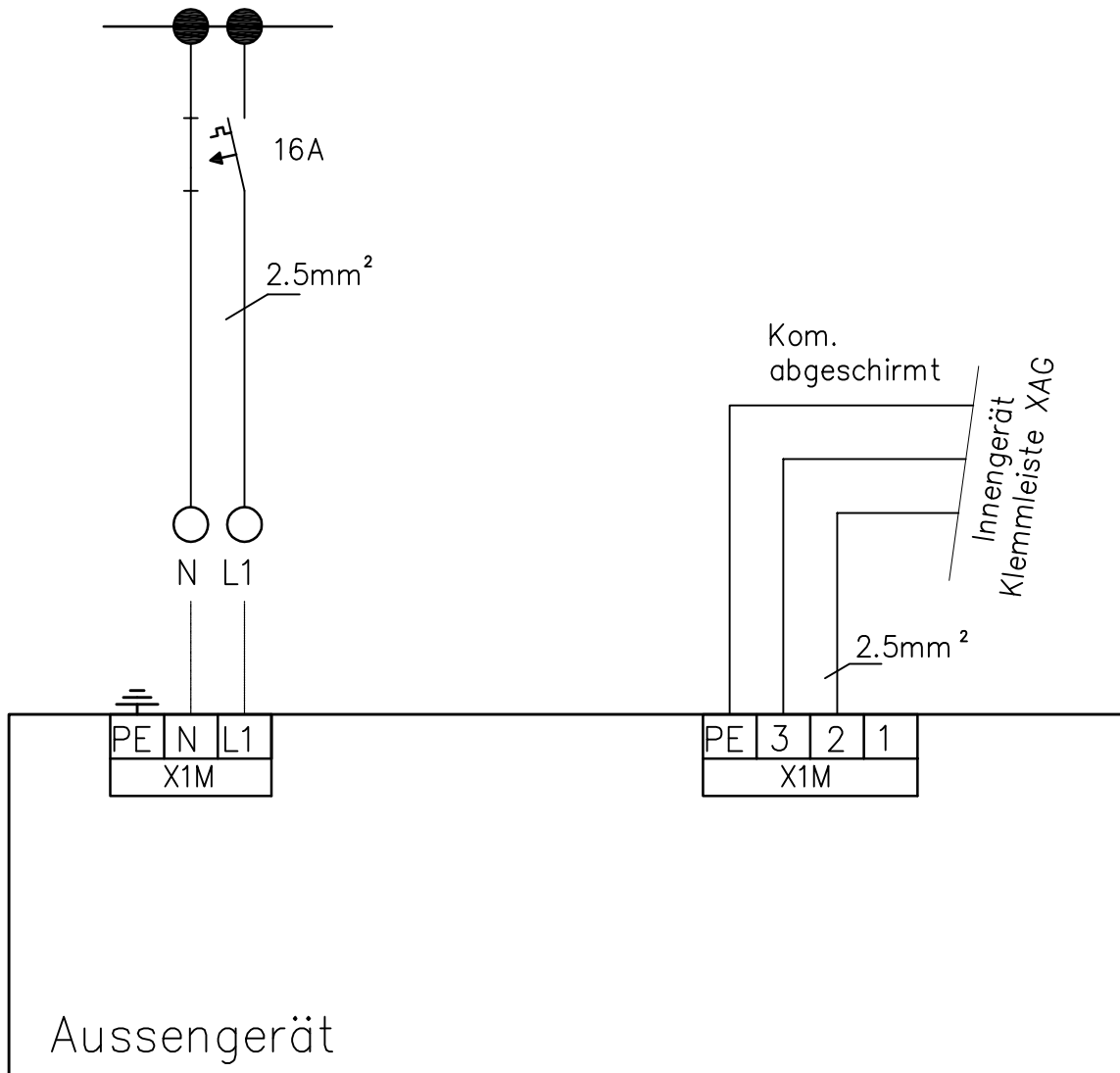

Einspeisung Innengerät

Stromversorgung
Innengerät
230V 3x2,5mm²

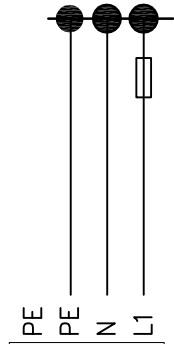

OPTIONAL
Raumregler DHE U1
4x0,75mm²/Signal

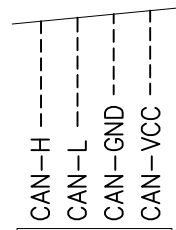

OPTIONAL
Brennersperrkontakt
230V BSK-Kabel

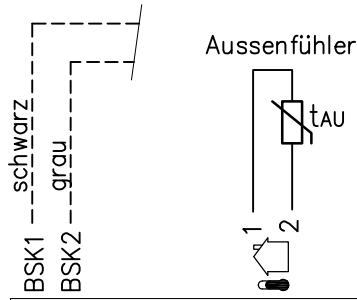

EVU

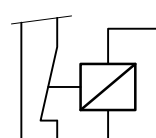

OPTIONAL
Raumthermostat
230V

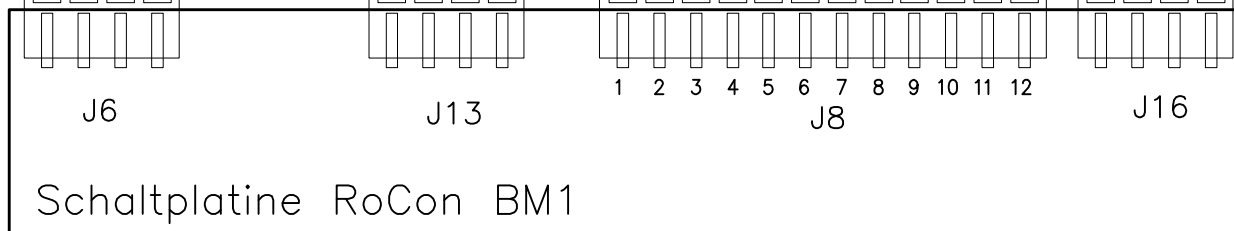
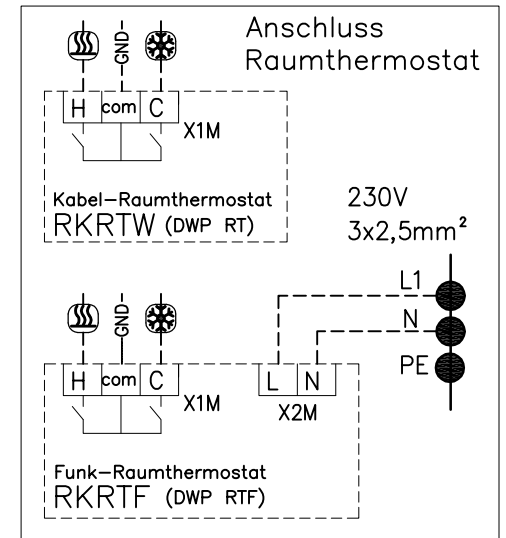
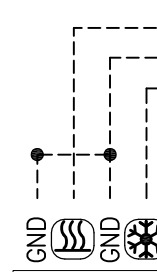

Notheizung & WW
DWP BU9
3x400V 5x2.5mm²

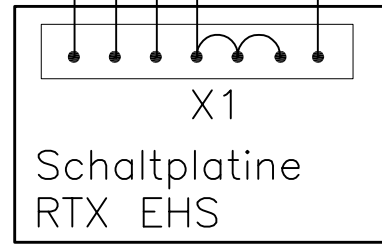
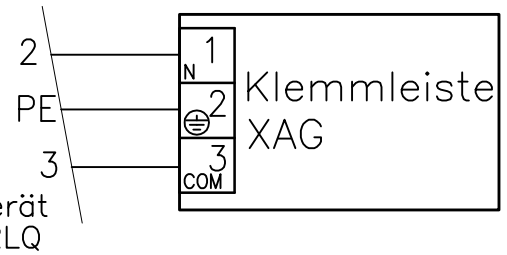
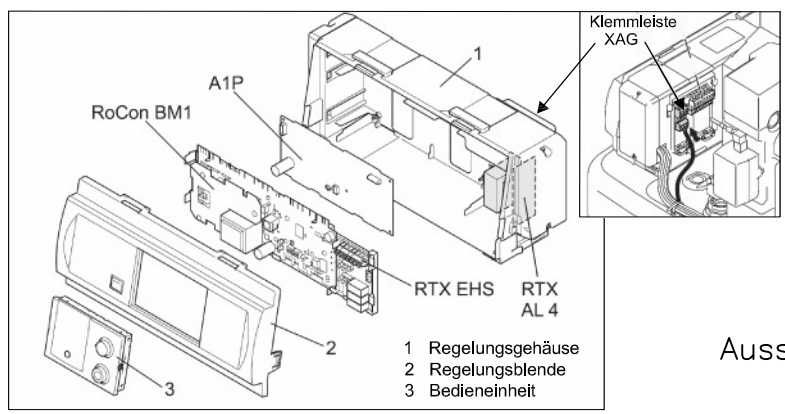
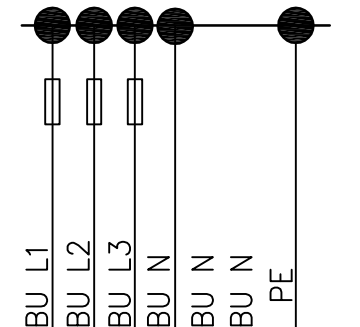

Übersicht Schaltplatten

Gesamtanschlussplan HPSU BC 4–8 kW

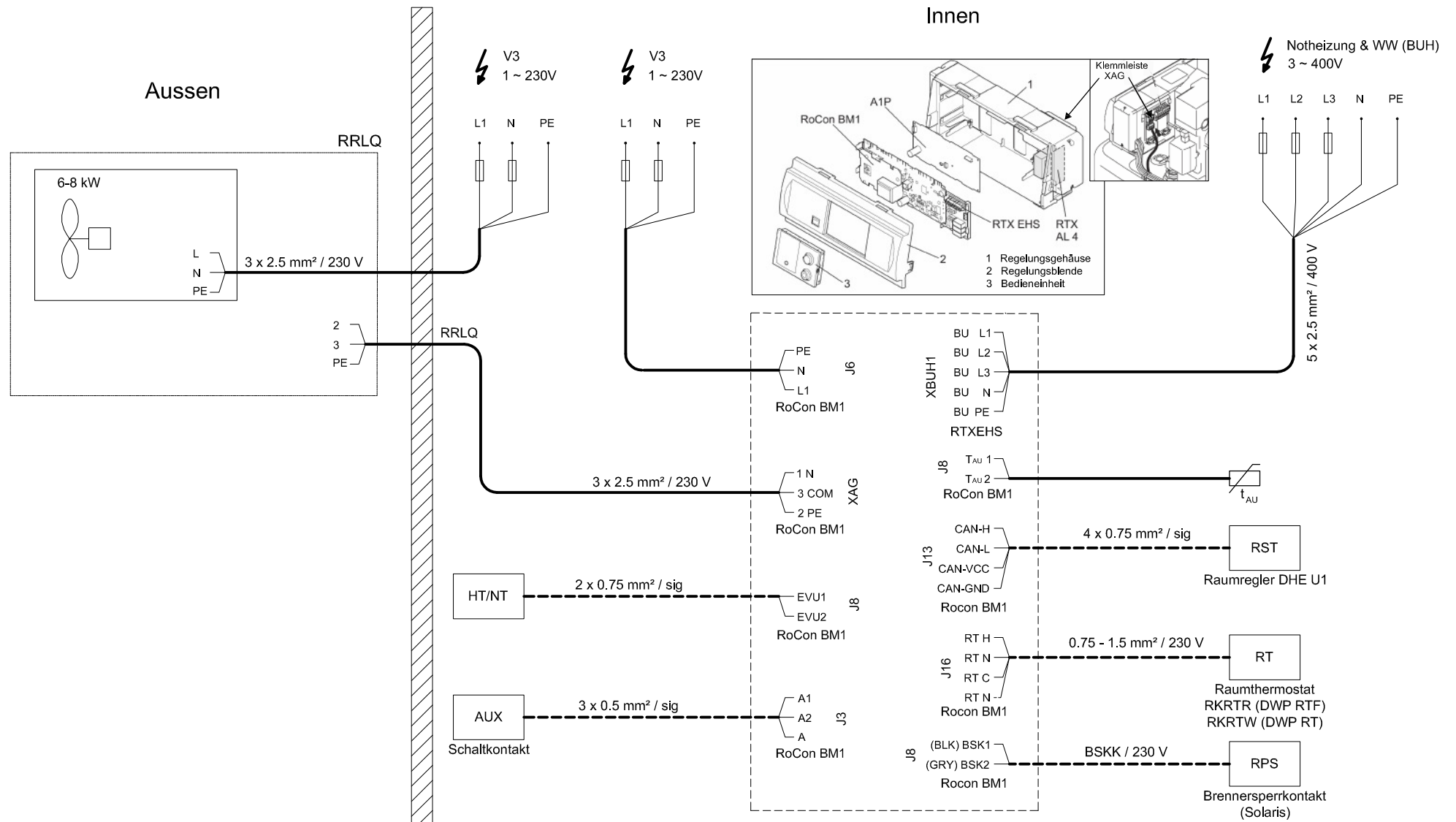

domotec

Typ:
HPSU compact 4–8 kW

Zeichn.-Nr.
DPE\HPSU BC 4–8.4–B

Datum: 18.07.13 MSI